

DETALLE 1
esc. 1:25

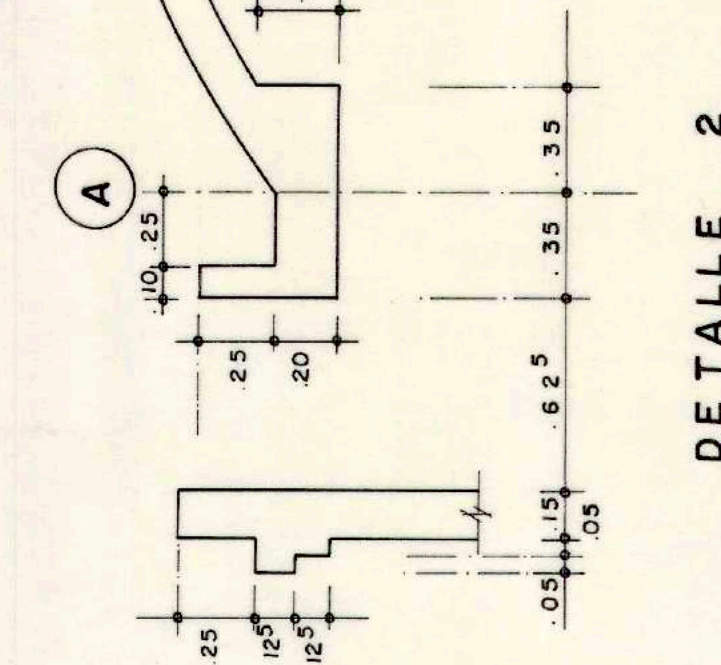

CORTE A-A
esc. 1:25

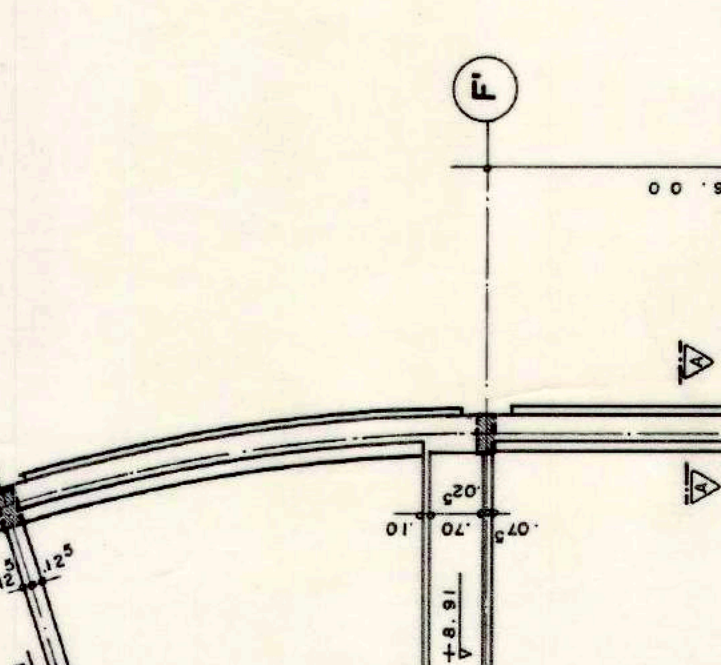

CORTE B-B
esc. 1:25

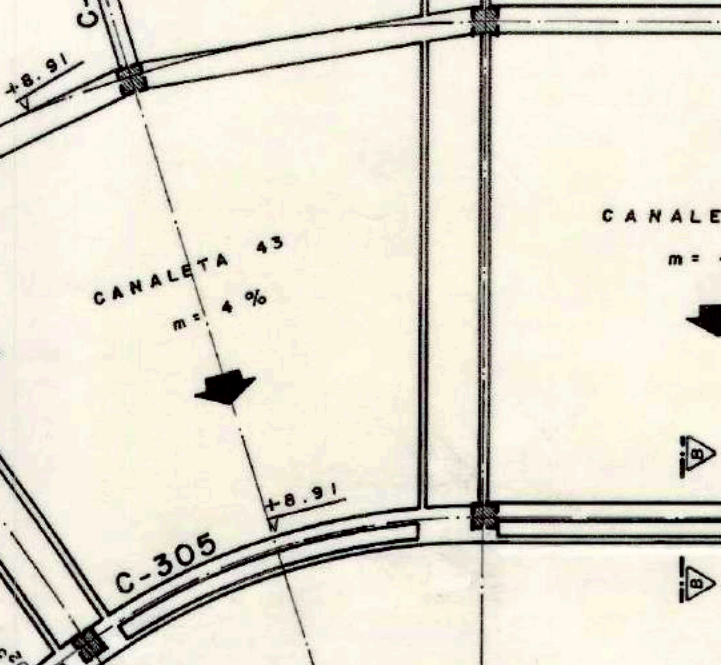

CORTE C-C
esc. 1:25

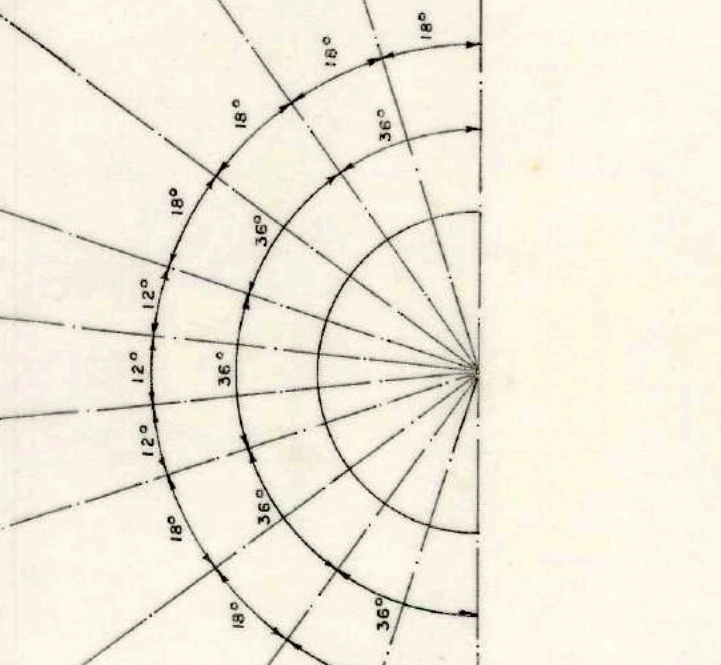

CORTE D-D
esc. 1:50

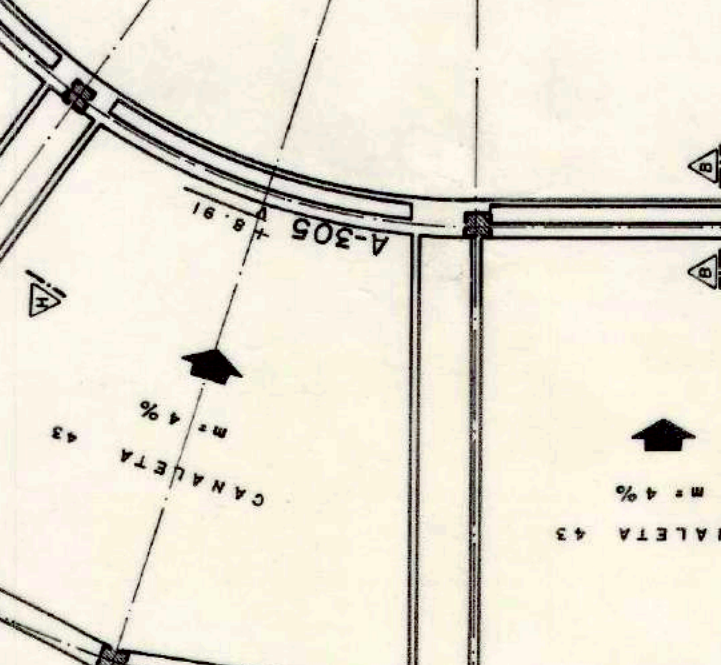

CORTE E-E
esc. 1:25

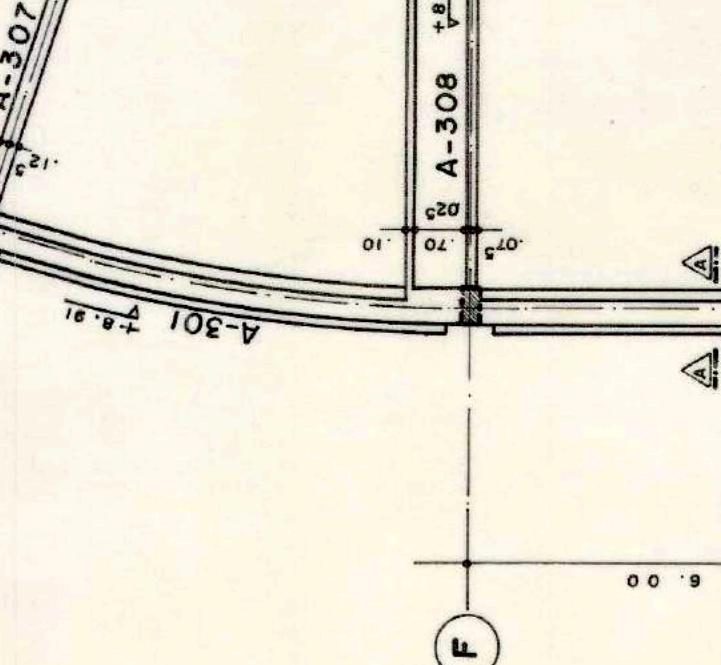

CORTE F-F
esc. 1:25



CORTE G-G
esc. 1:25

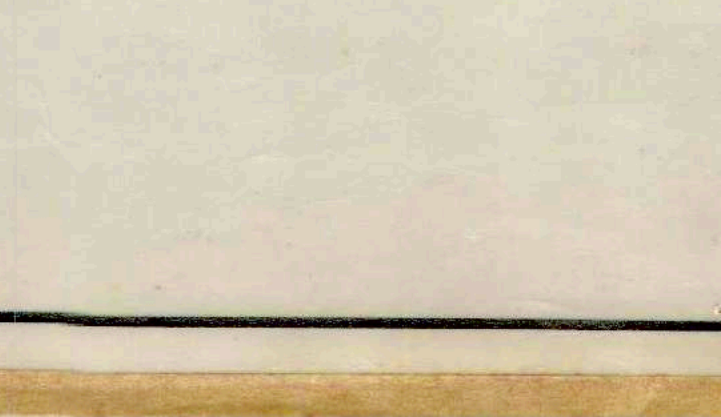

CORTE H-H
esc. 1:25

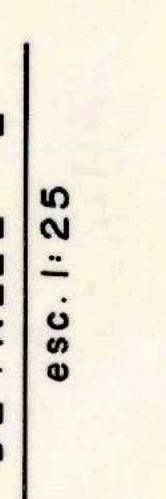

DETALLE 2
esc. 1:25

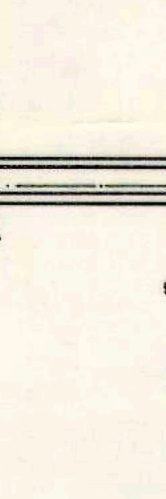

DETALLE 3
esc. 1:25



DETALLE 4
esc. 1:10

PLANTA DE CUBIERTA
esc. 1:100

CUADRO DE COLUMNAS

TIPO	SECCION	NIVELES
1	3 x 30 x 30	N. - 2.75 a N. + 8.91
2	5 x 35 x 35	N. - 2.75 a N. + 8.91
3	5 x 35 x 35	N. - 2.75 a N. + 8.91
4	3 x 30 x 30	N. - 2.75 a N. + 8.91
5	3 x 35 x 35	N. - 2.75 a N. + 8.91
6	3 x 35 x 35	N. - 1.00 a N. + 10.31
7	3 x 35 x 35	N. - 1.00 a N. + 10.31
8	3 x 30 x 30	N. - 1.00 a N. + 10.31
9	Ø 0.70	N. - 1.00 a N. + 10.31
10	3 x 30 x 30	N. - 1.00 a N. + 8.91
11	3 x 35 x 35	N. - 1.00 a N. + 8.91
12	3 x 35 x 35	N. - 1.00 a N. + 8.91
13	Ø 0.70	N. - 1.00 a N. + 8.91
PANTALLAS (TIPO)		NIVELES
A. B. C		N. - 2.75 a N. + 8.91
D. E. F		N. - 1.00 a N. + 8.91

NOTAS:
 ◊ Indica tipo de columna.
 Ver desplce de columnas en pl. n.º 9
 Ver desplce de pantallas en pl. n.º 10

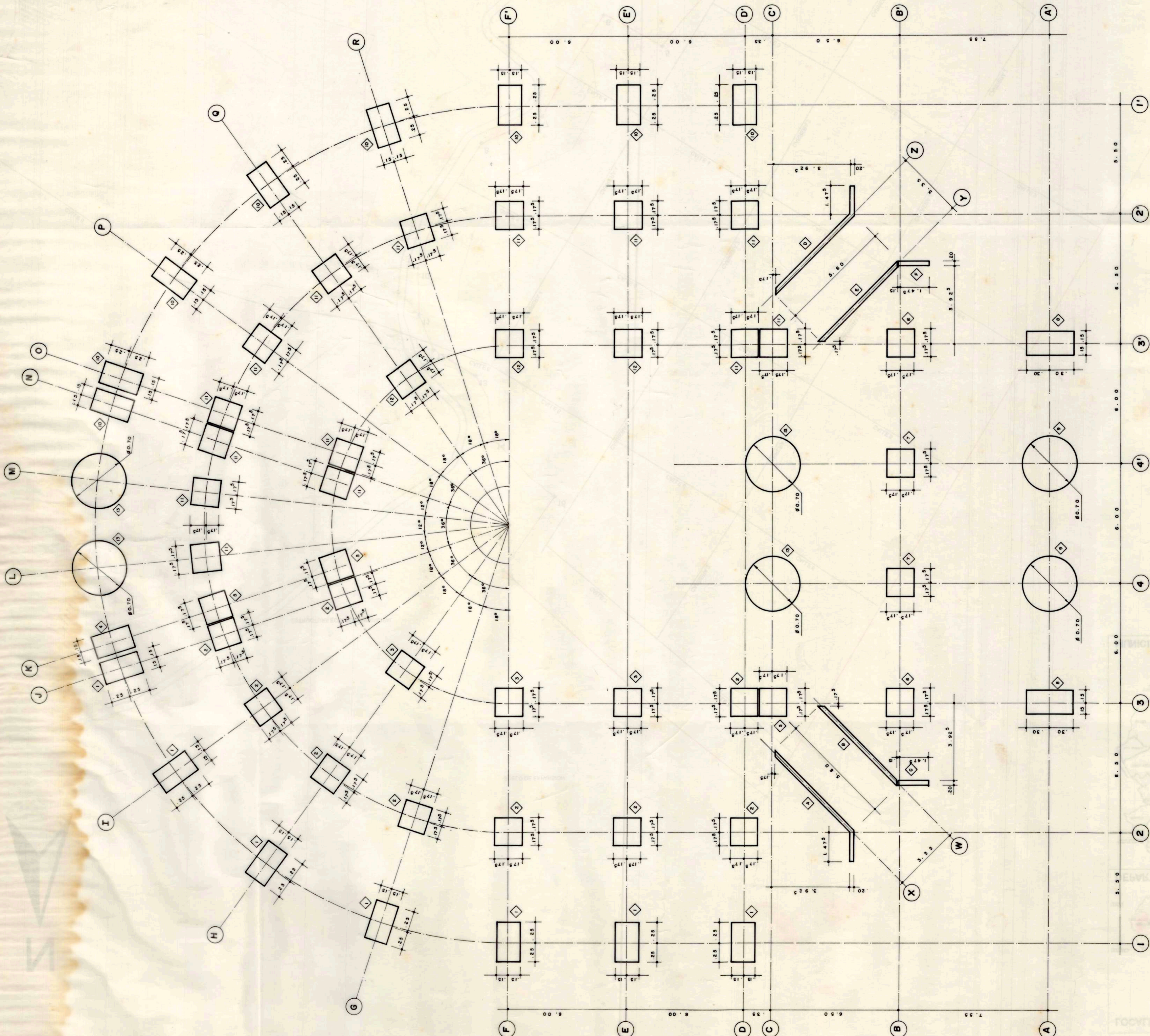

LOCALIZACION Y DESARROLLO DE COLUMNAS
ejes esc. 1:100
columnas esc. 1:25

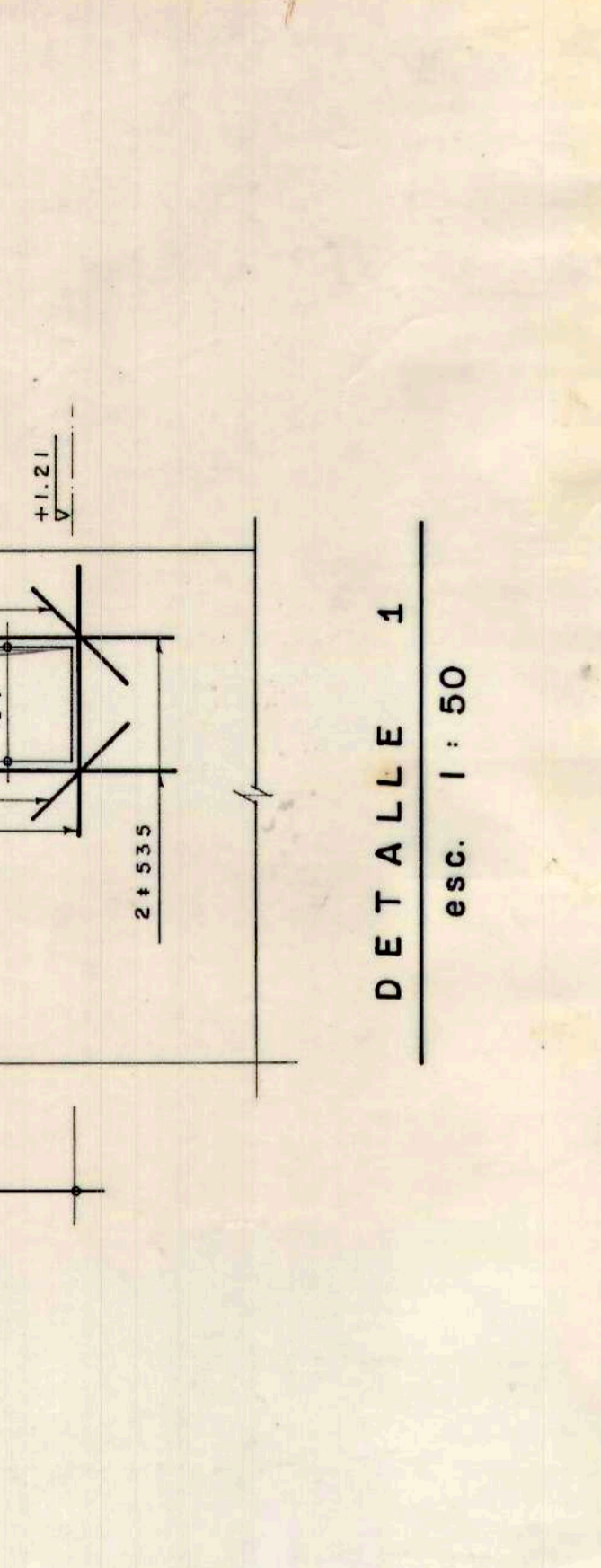
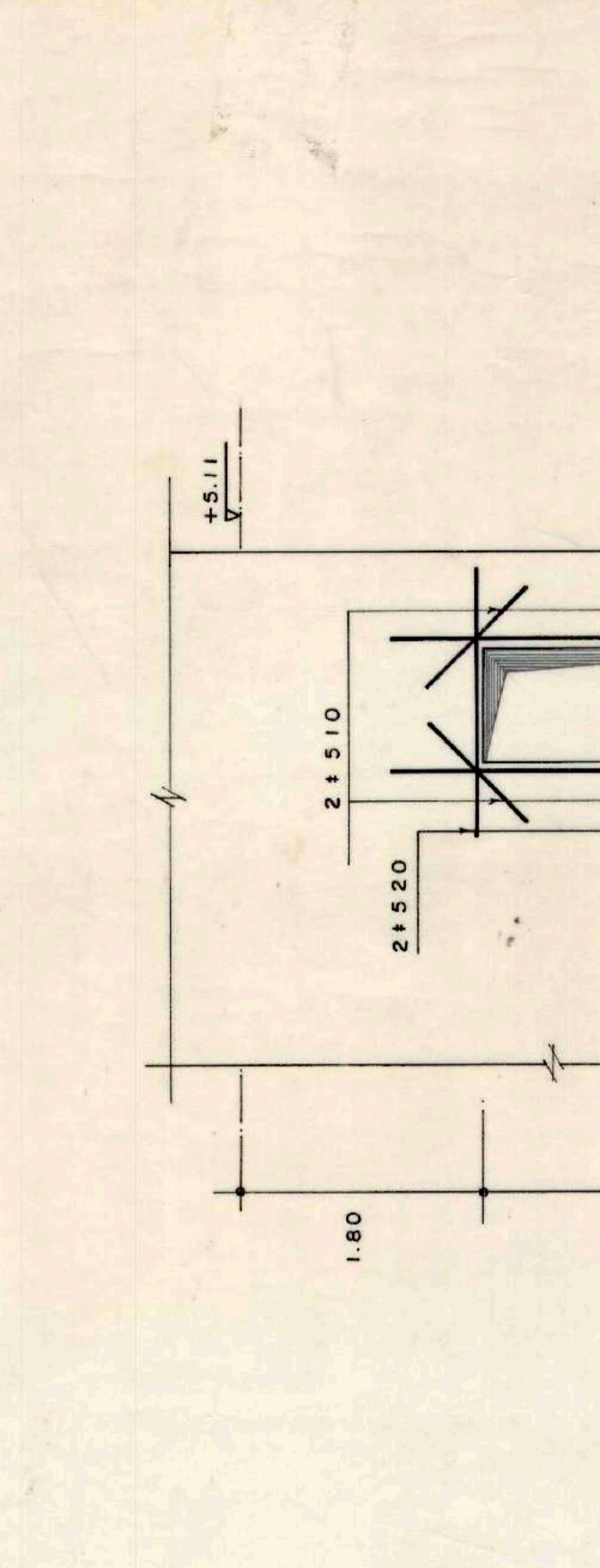
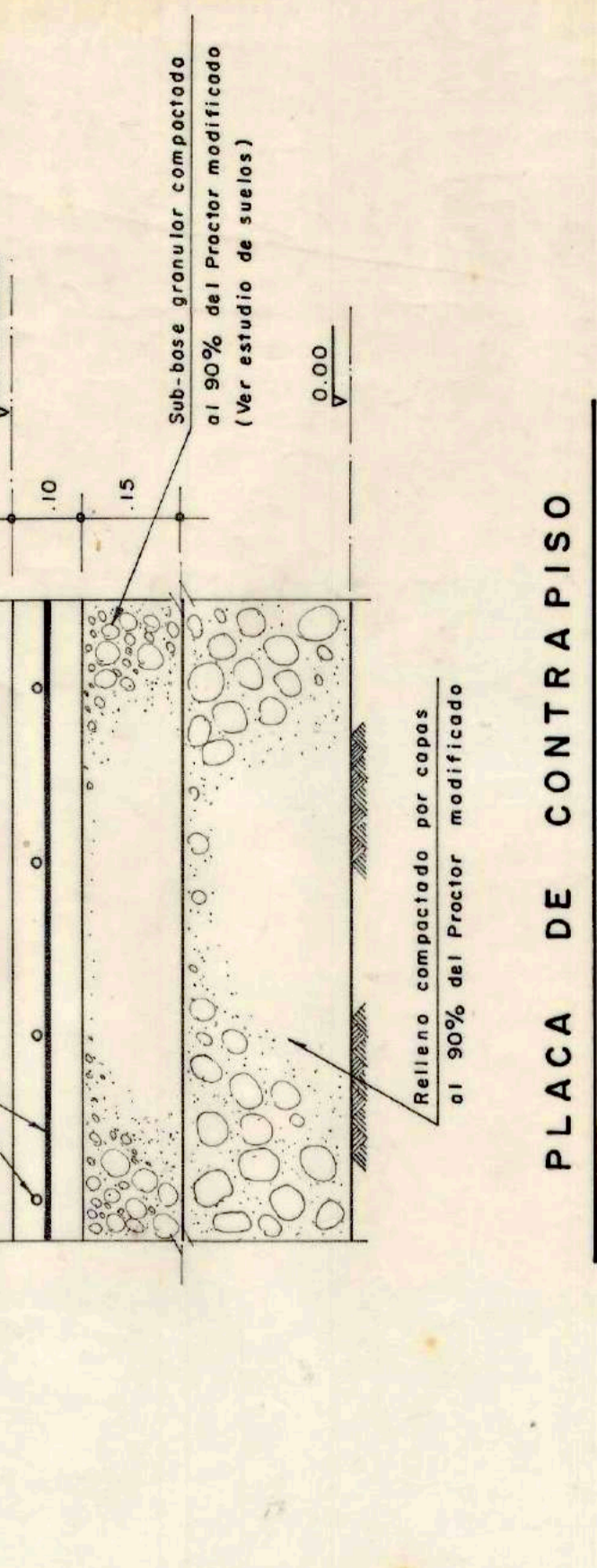
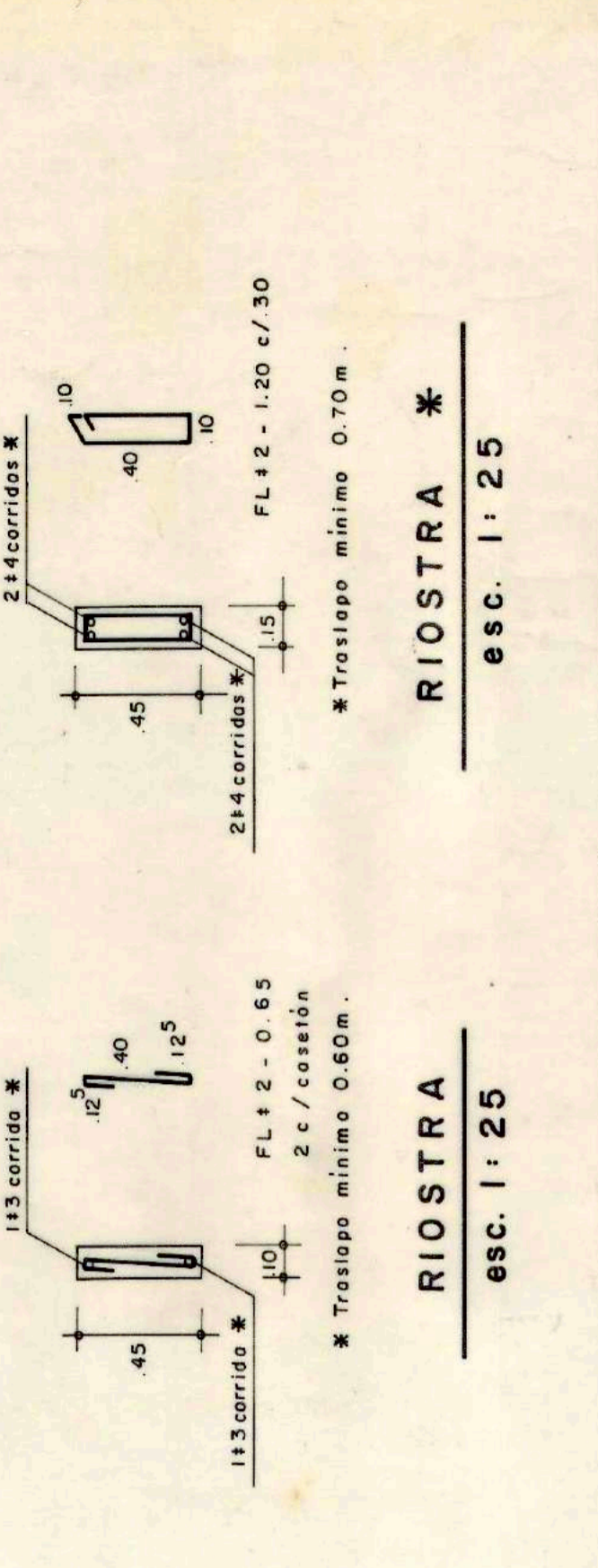
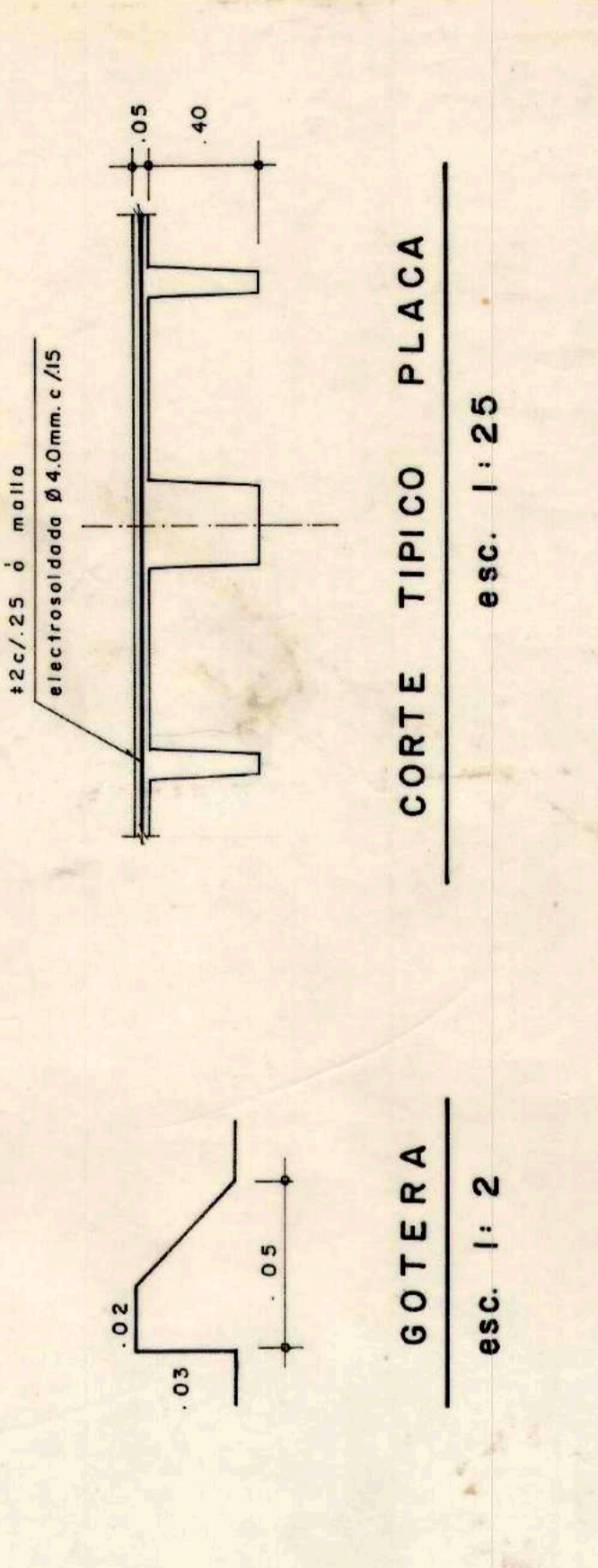
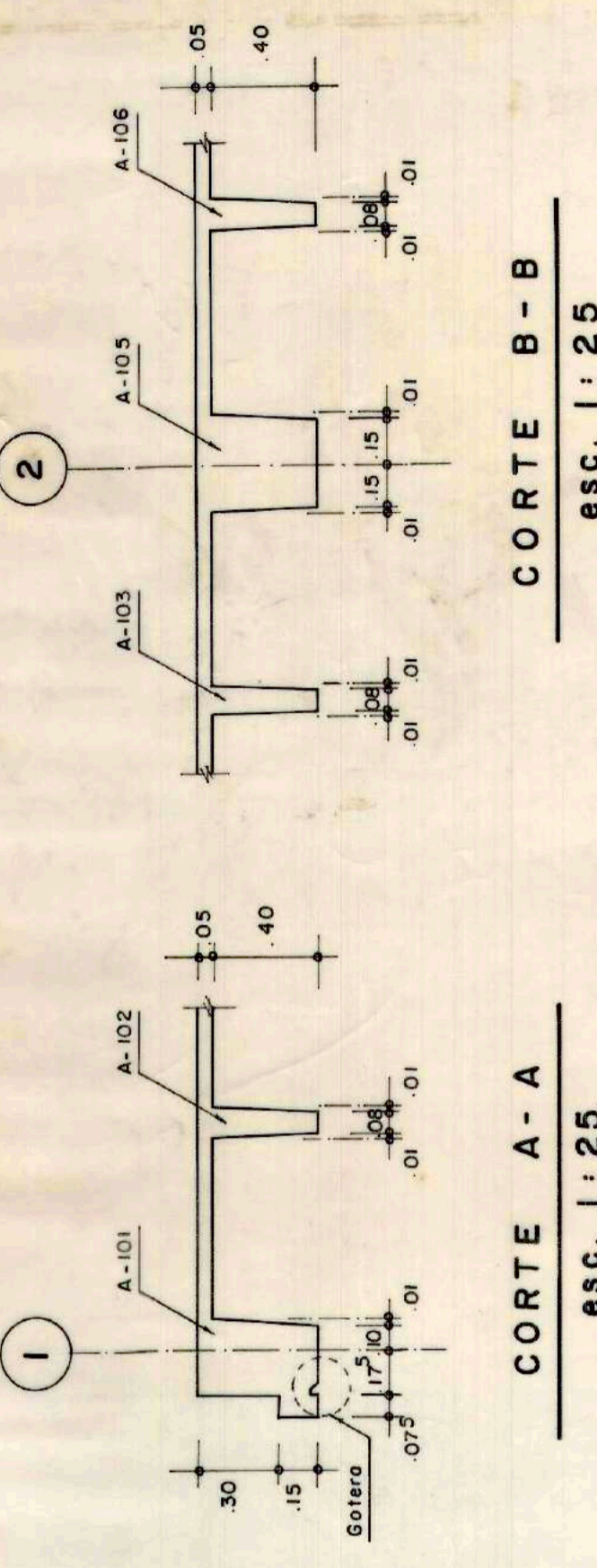
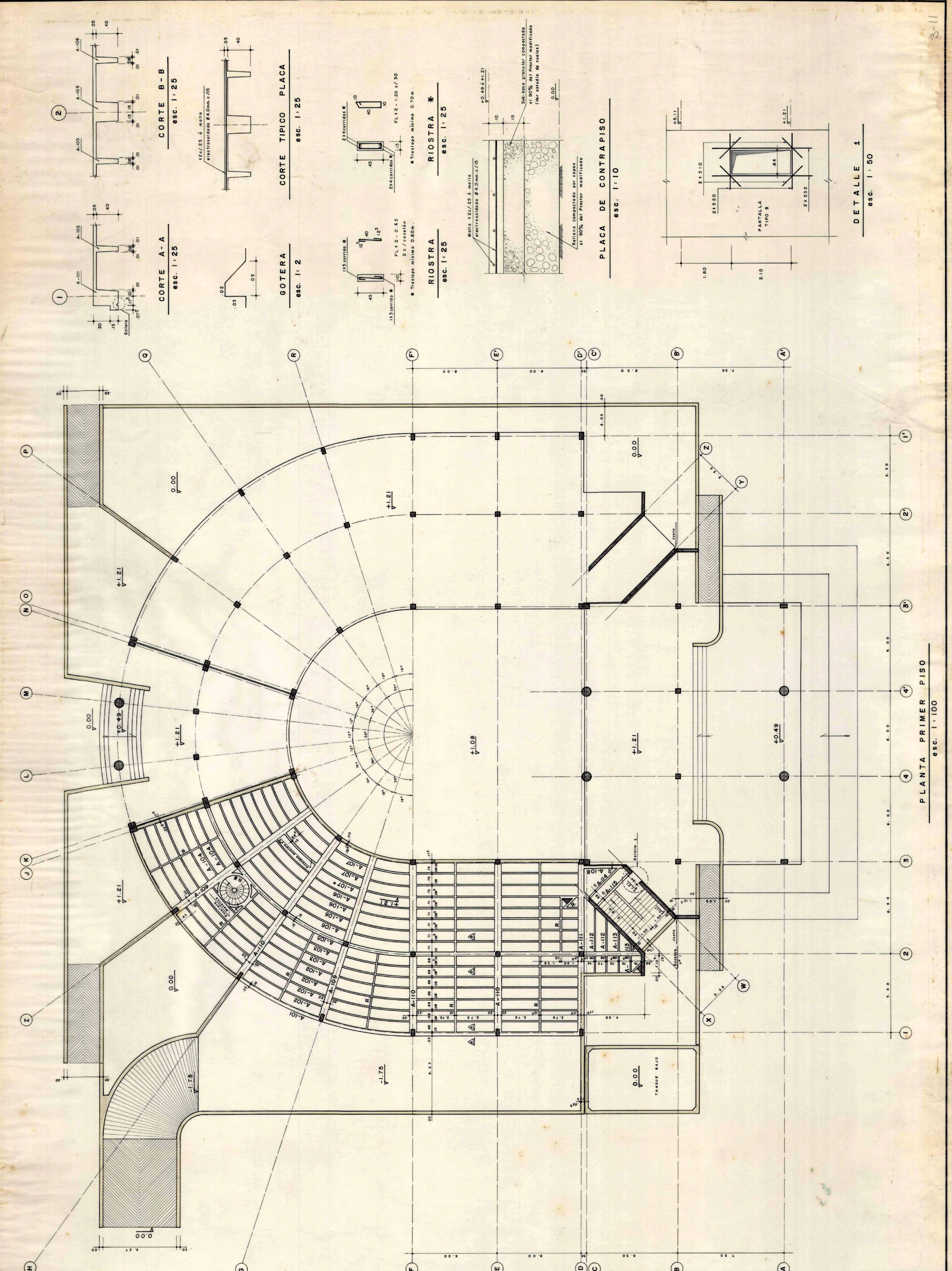

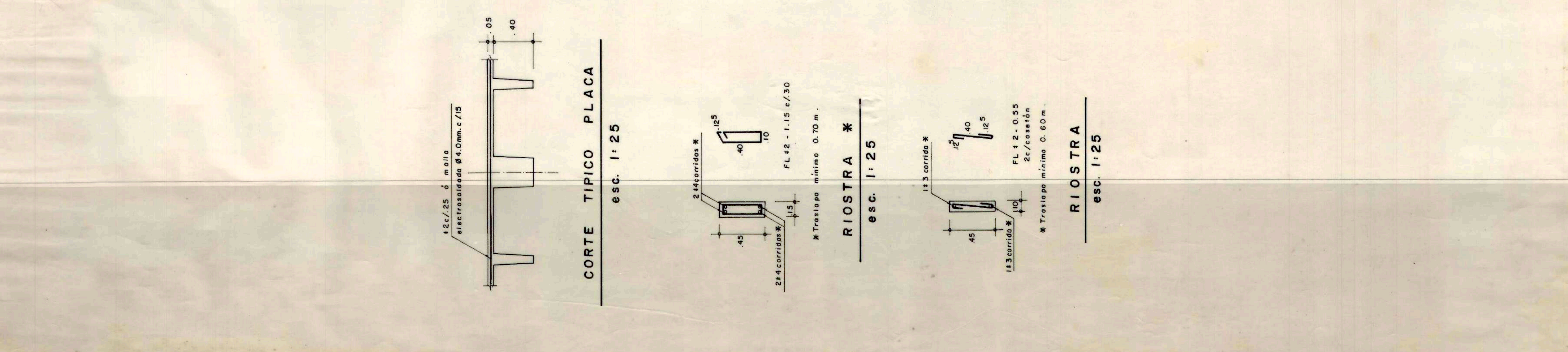
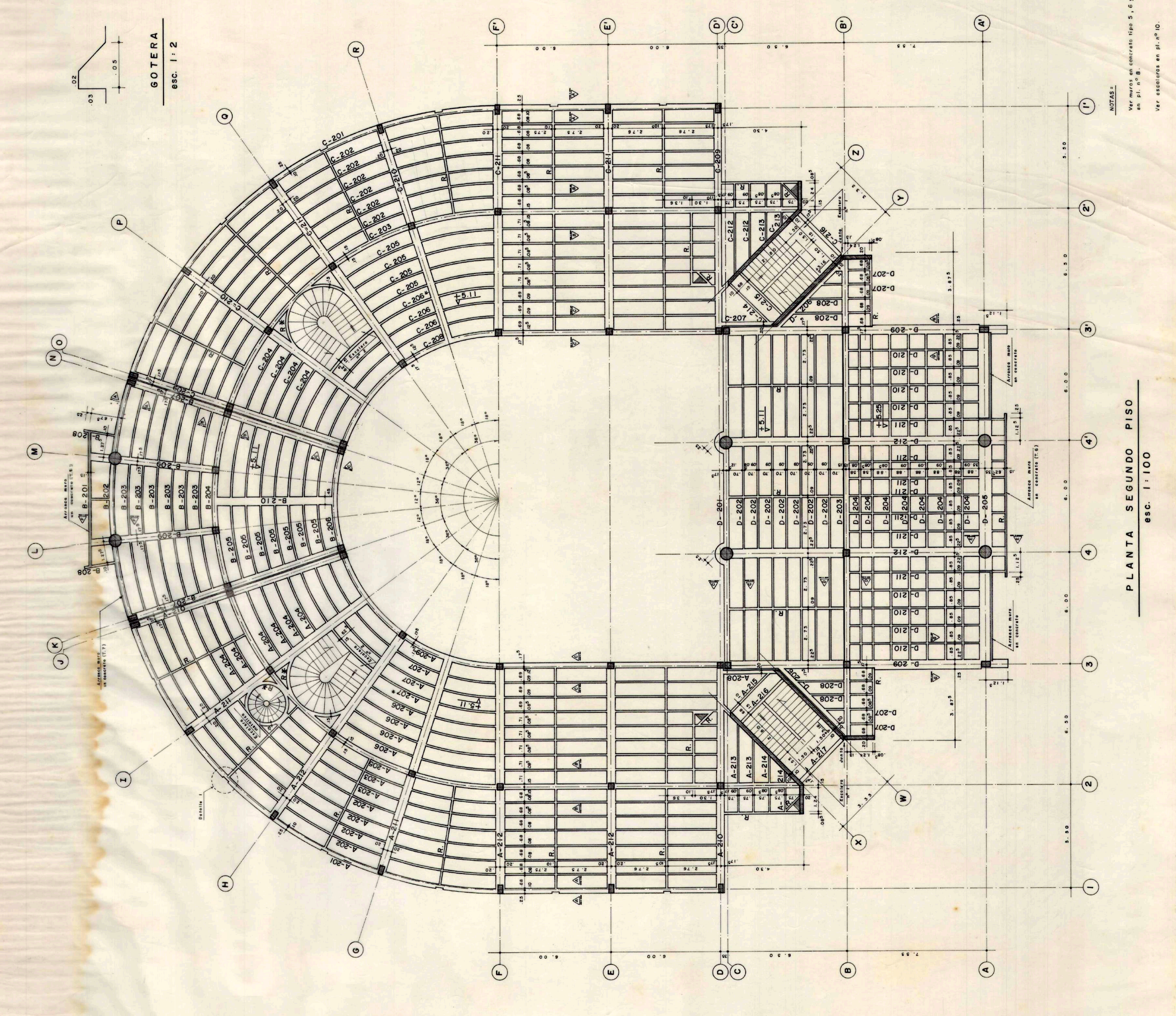
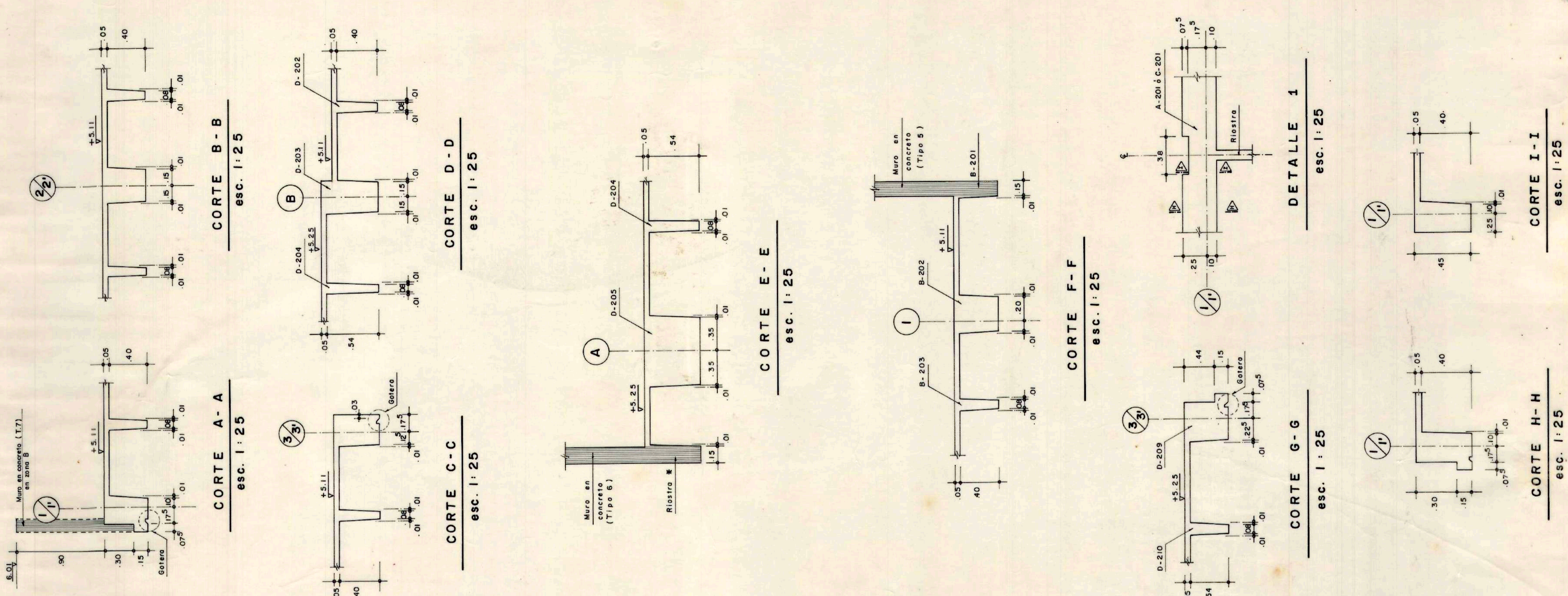

NOTAS:
 Ver muros en concreto tipo 5, 6 y 7 en pl. n.º 8.
 Ver especificos en pl. n.º 10.

PLANTA SEGUNDO PISO
esc. 1 : 100

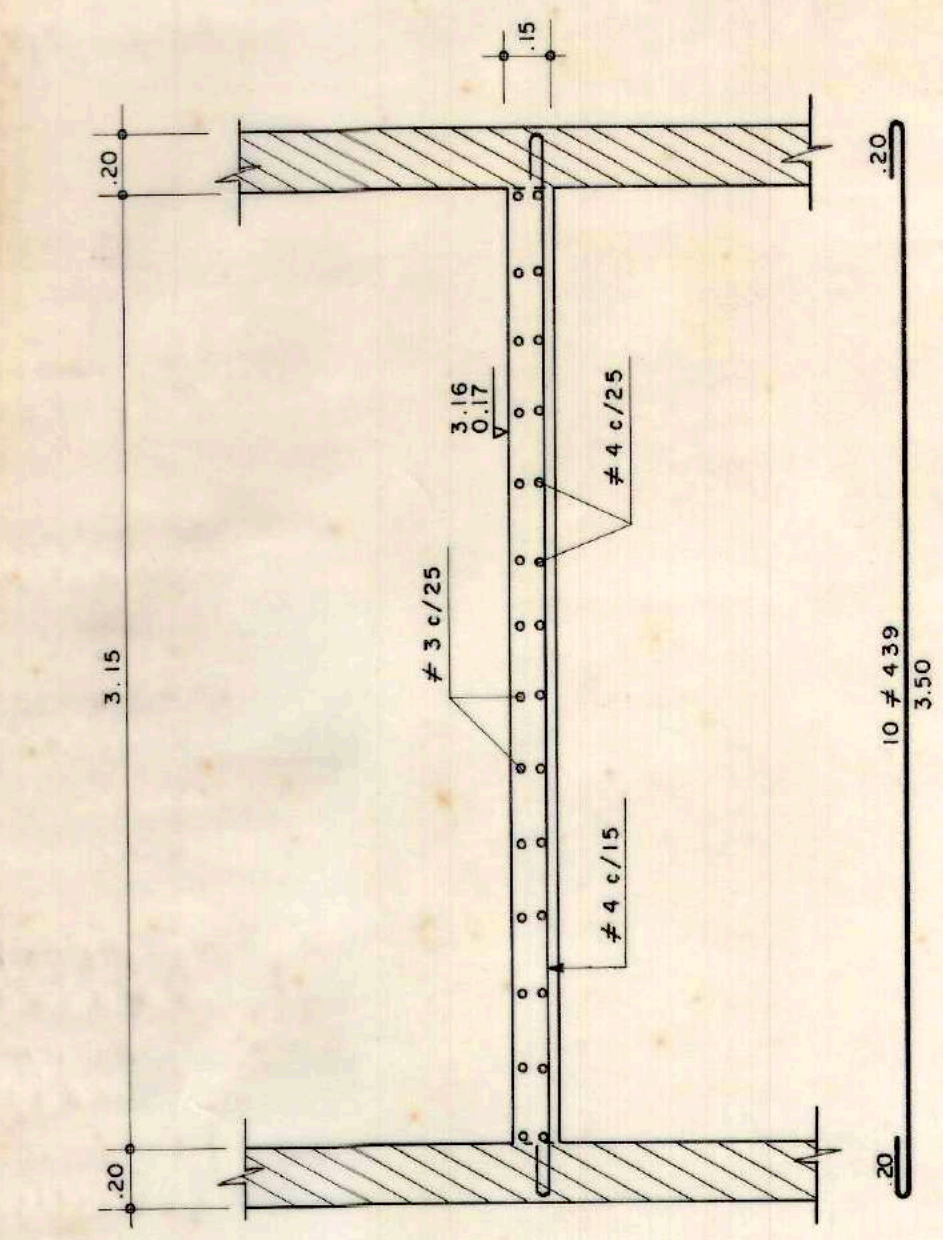

CORTE 3 - 3
esc. 1:25

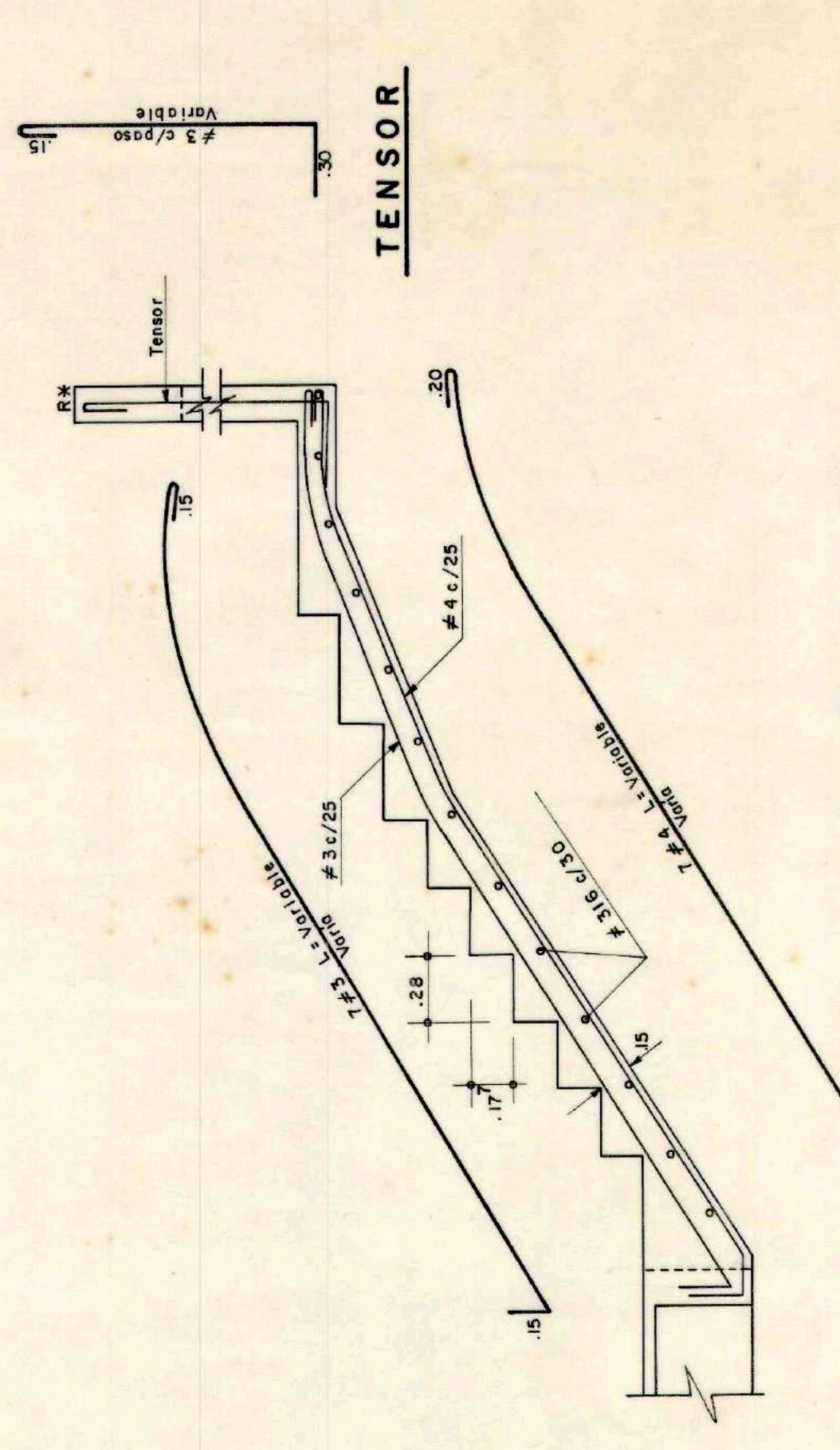

CORTE 6 - 6
esc. 1:25

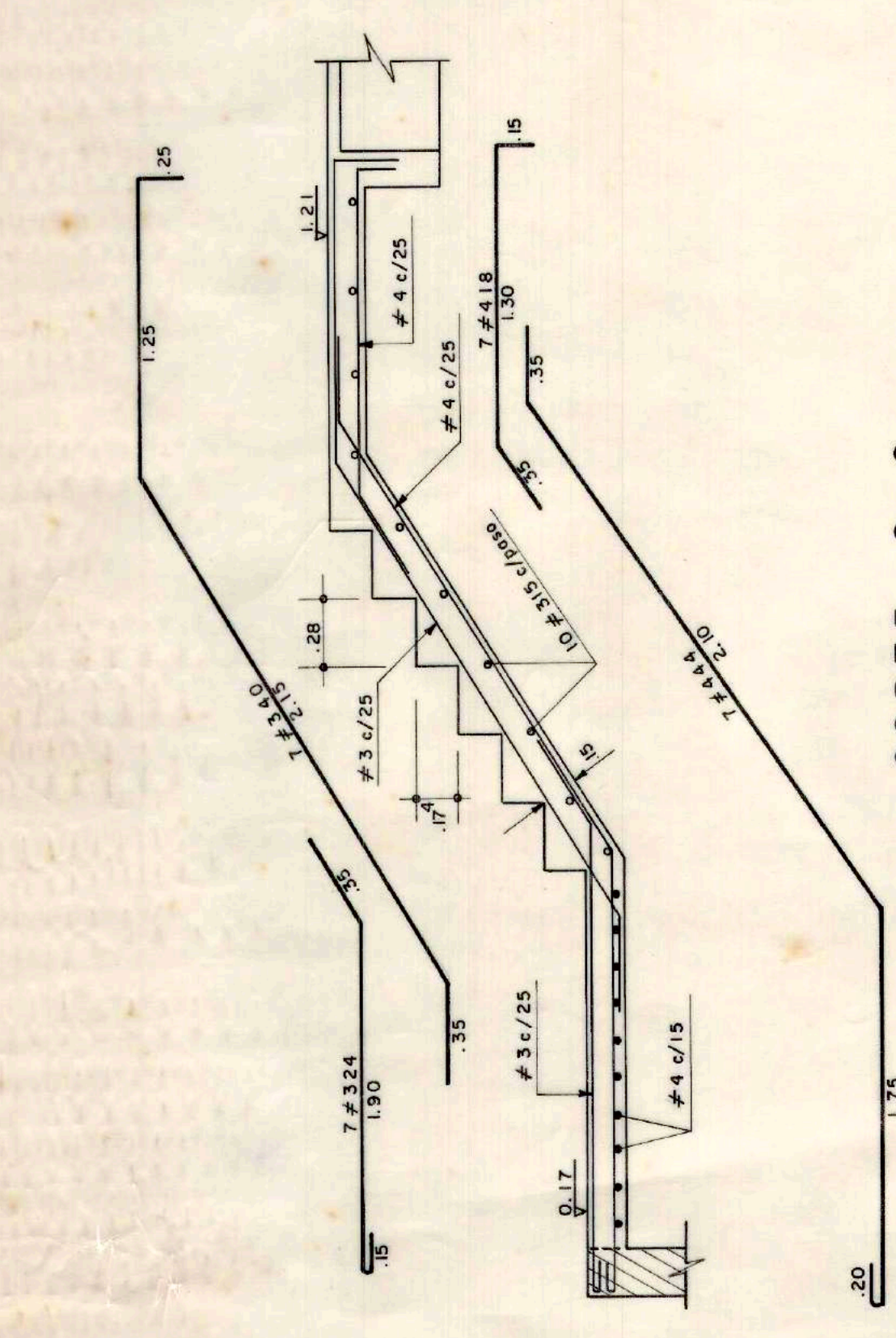

CORTE 2 - 2
esc. 1:25

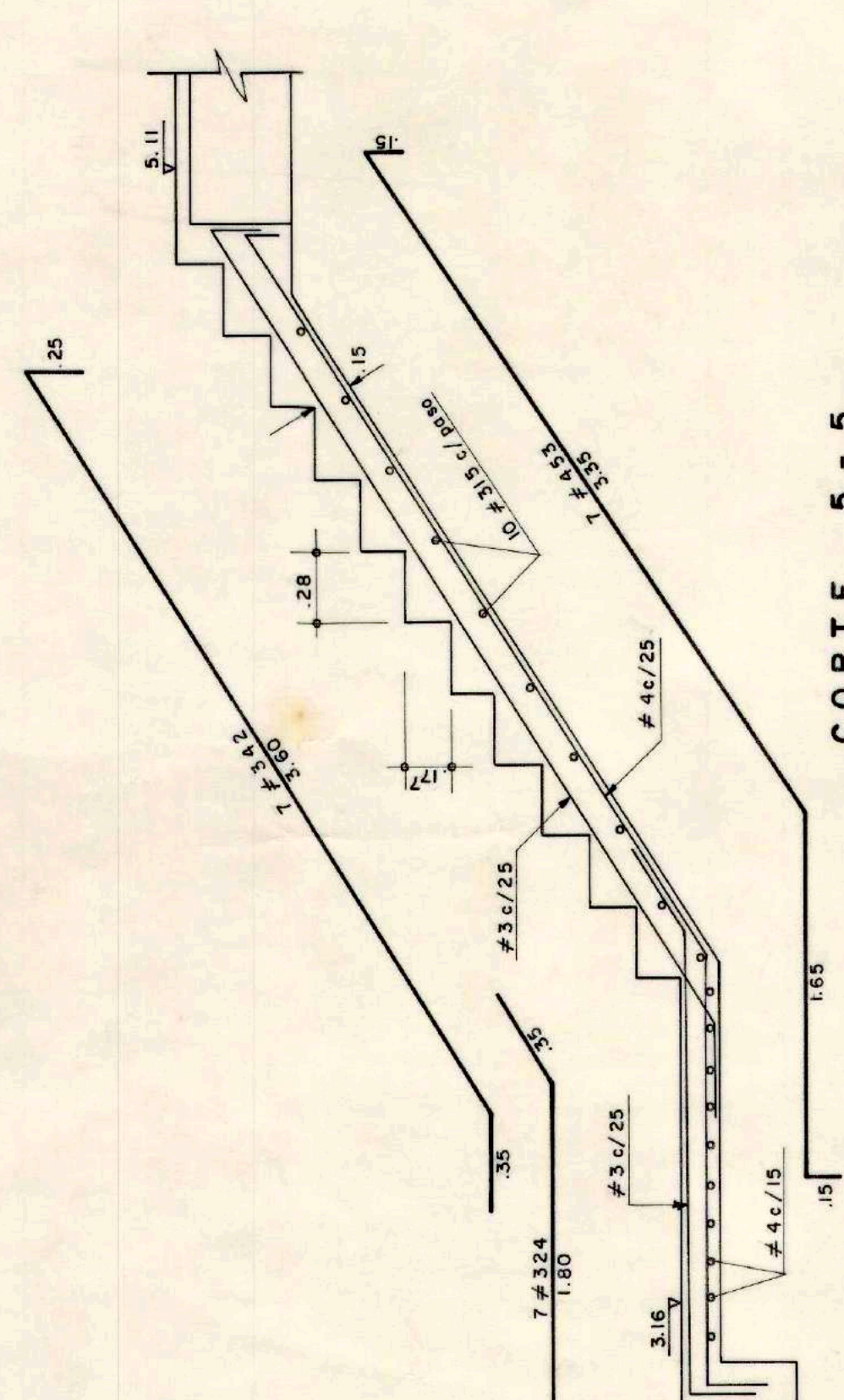

CORTE 5 - 5
esc. 1:25

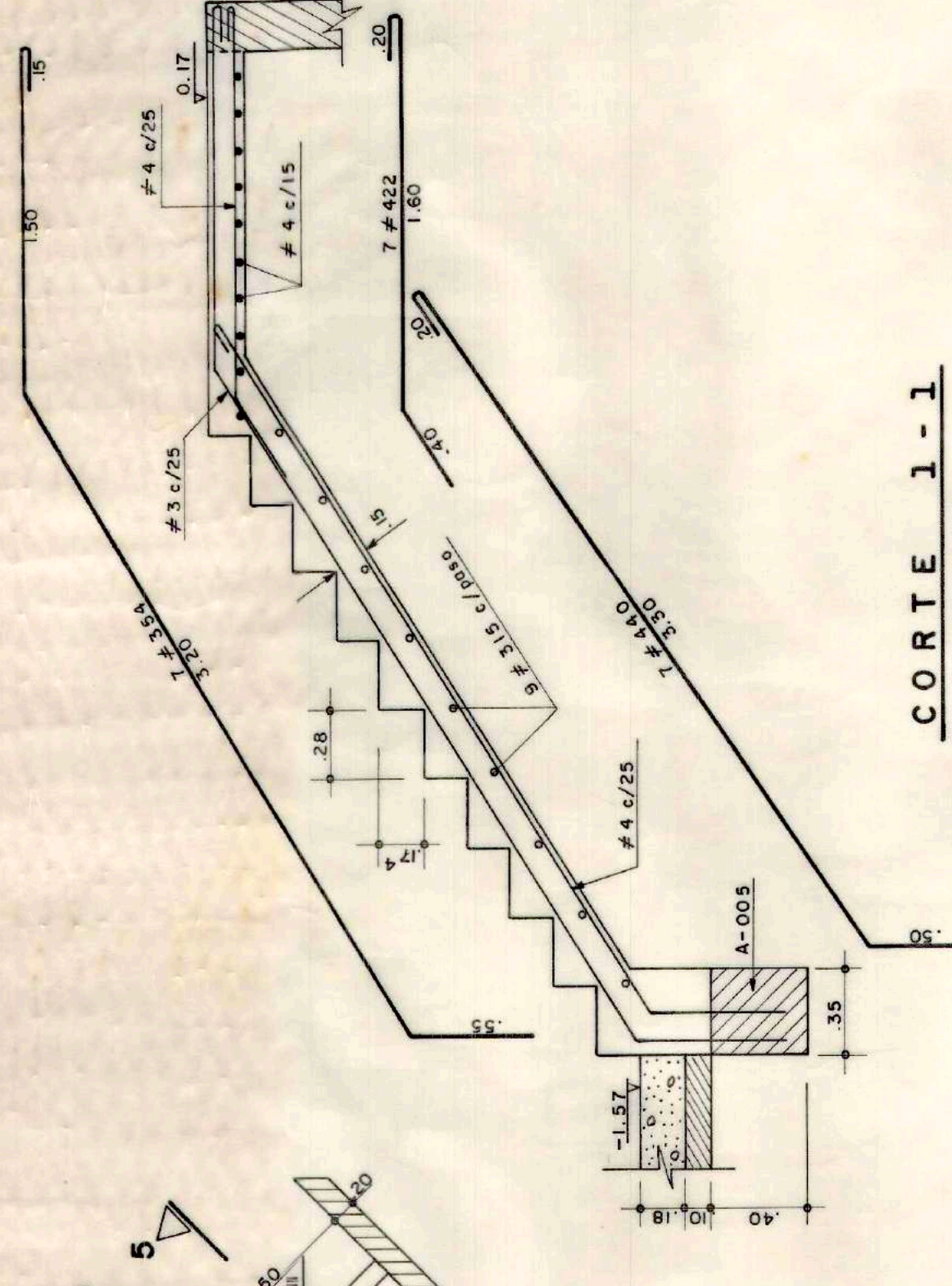

CORTE 1 - 1
esc. 1:25

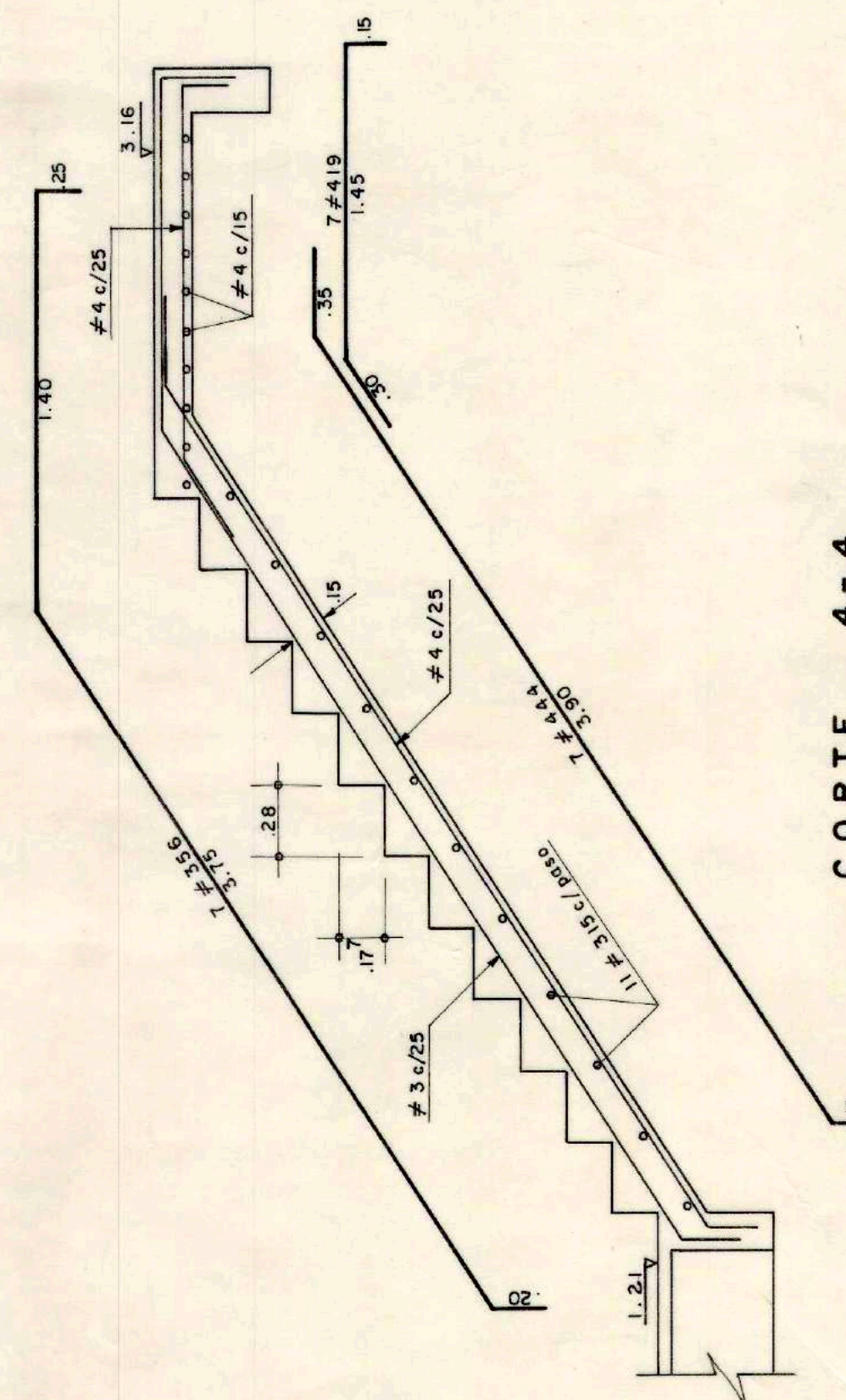

CORTE 4 - 4
esc. 1:25

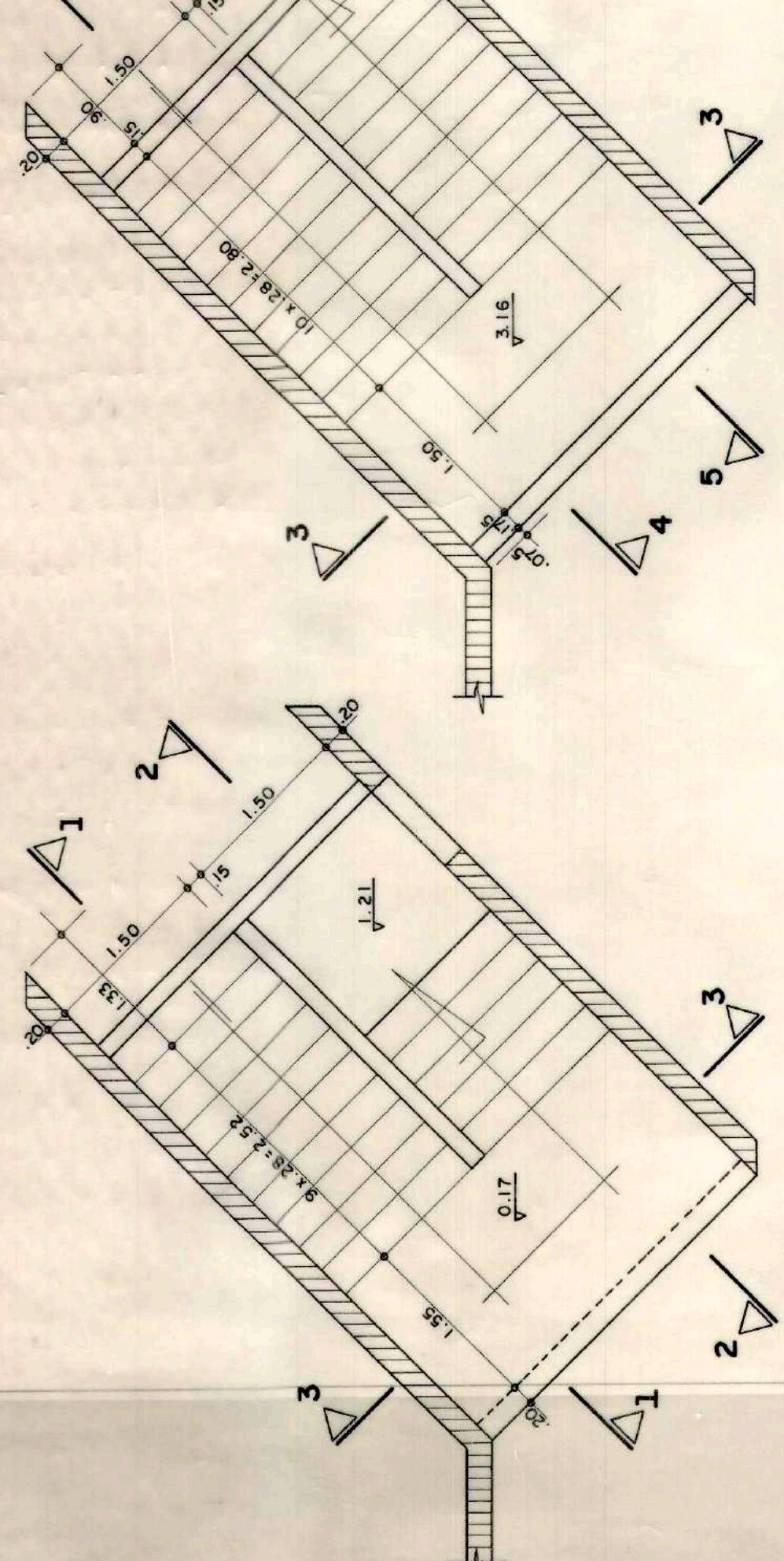

PLANTAS ESCALERA N° 1
esc. 1:50

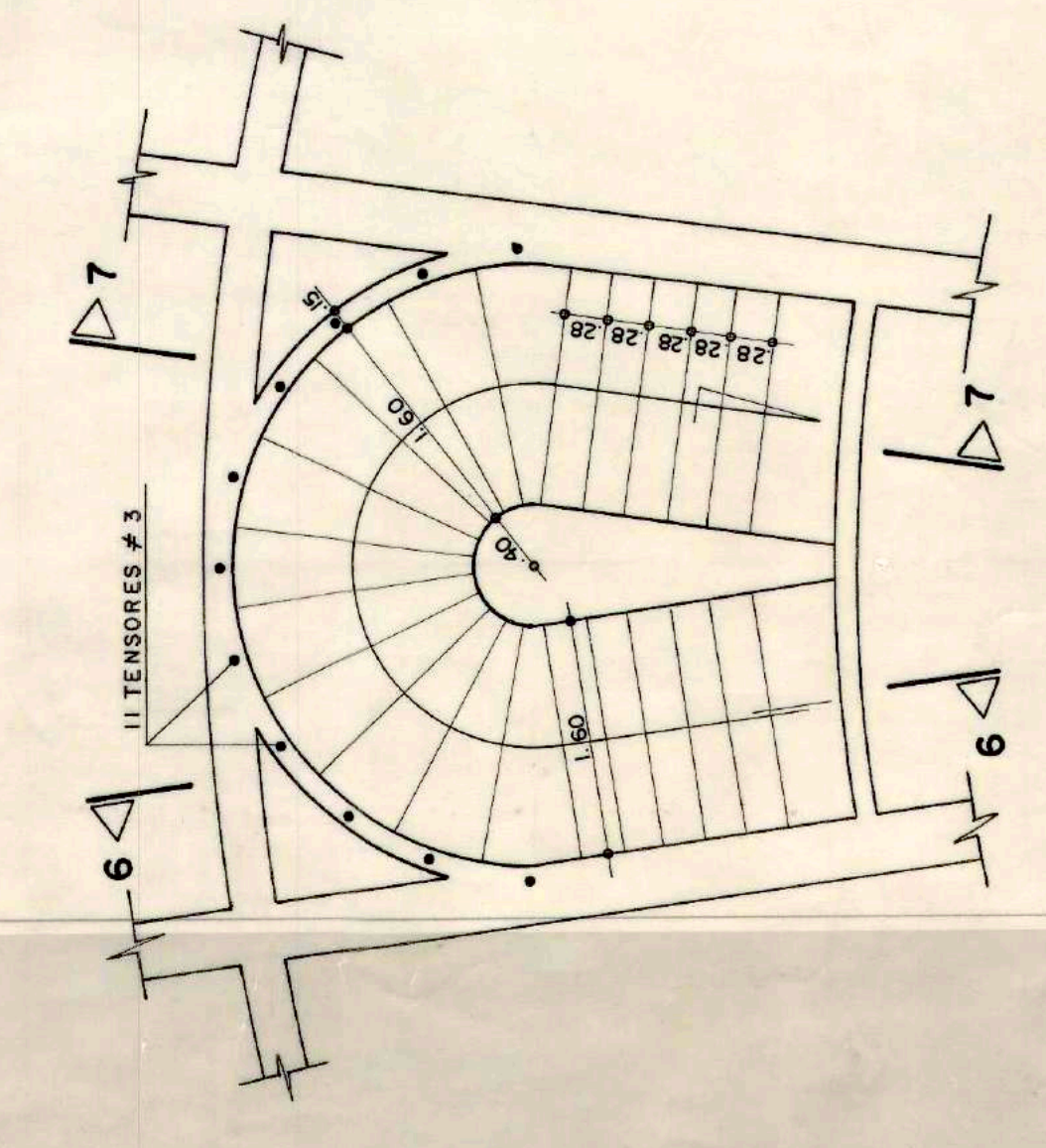

PLANTA ESCALERA N° 2
esc. 1:50

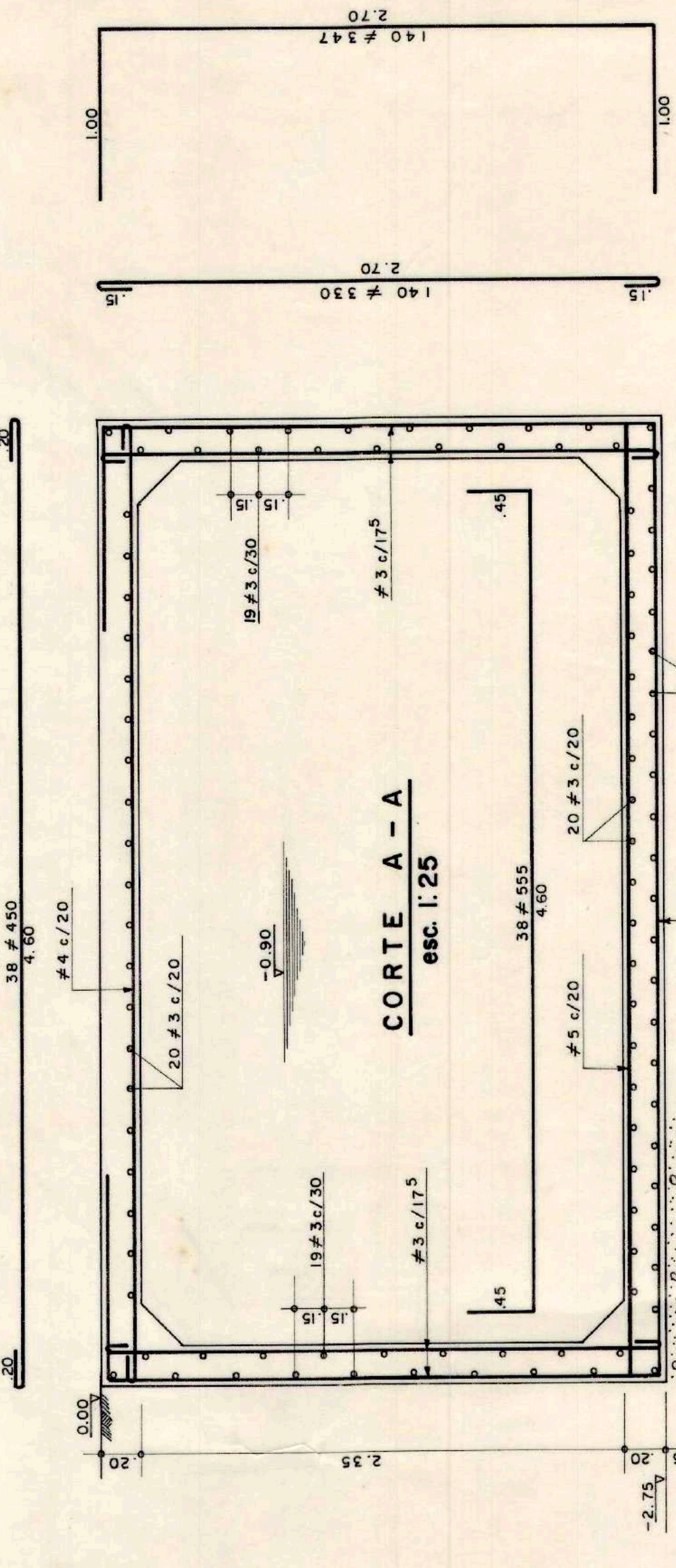

CORTE A - A
esc. 1:25

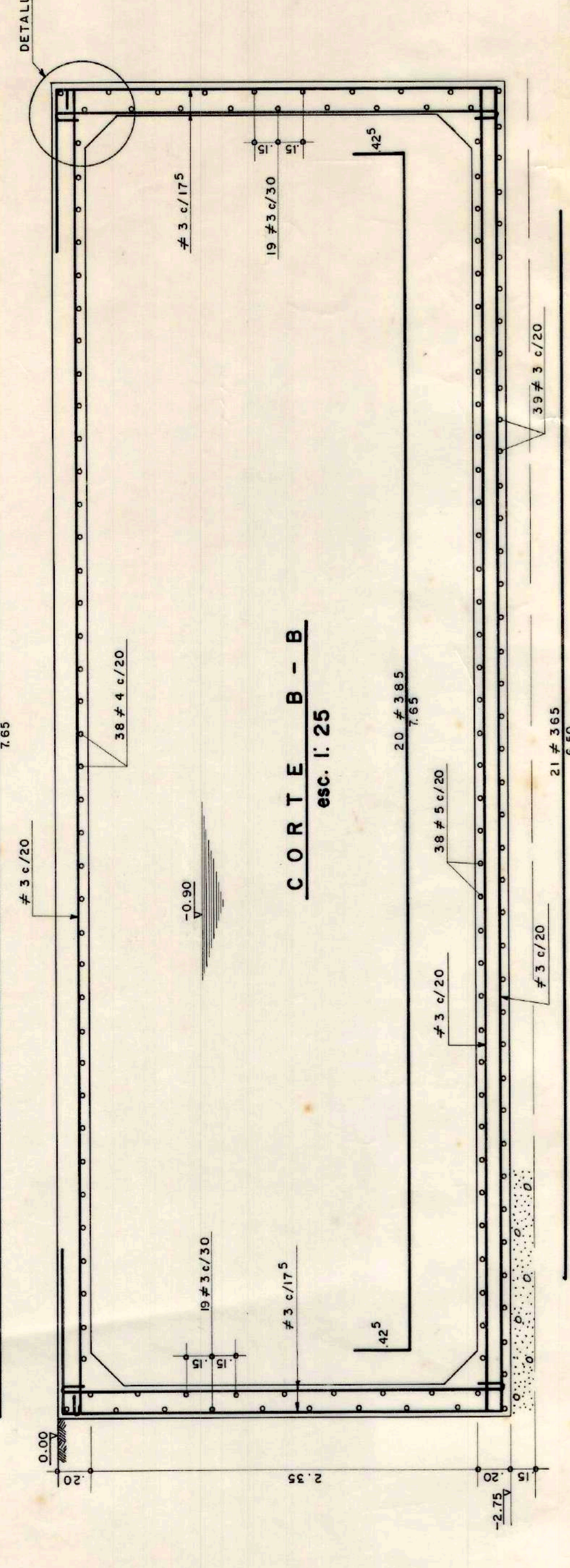

CORTE B - B
esc. 1:25

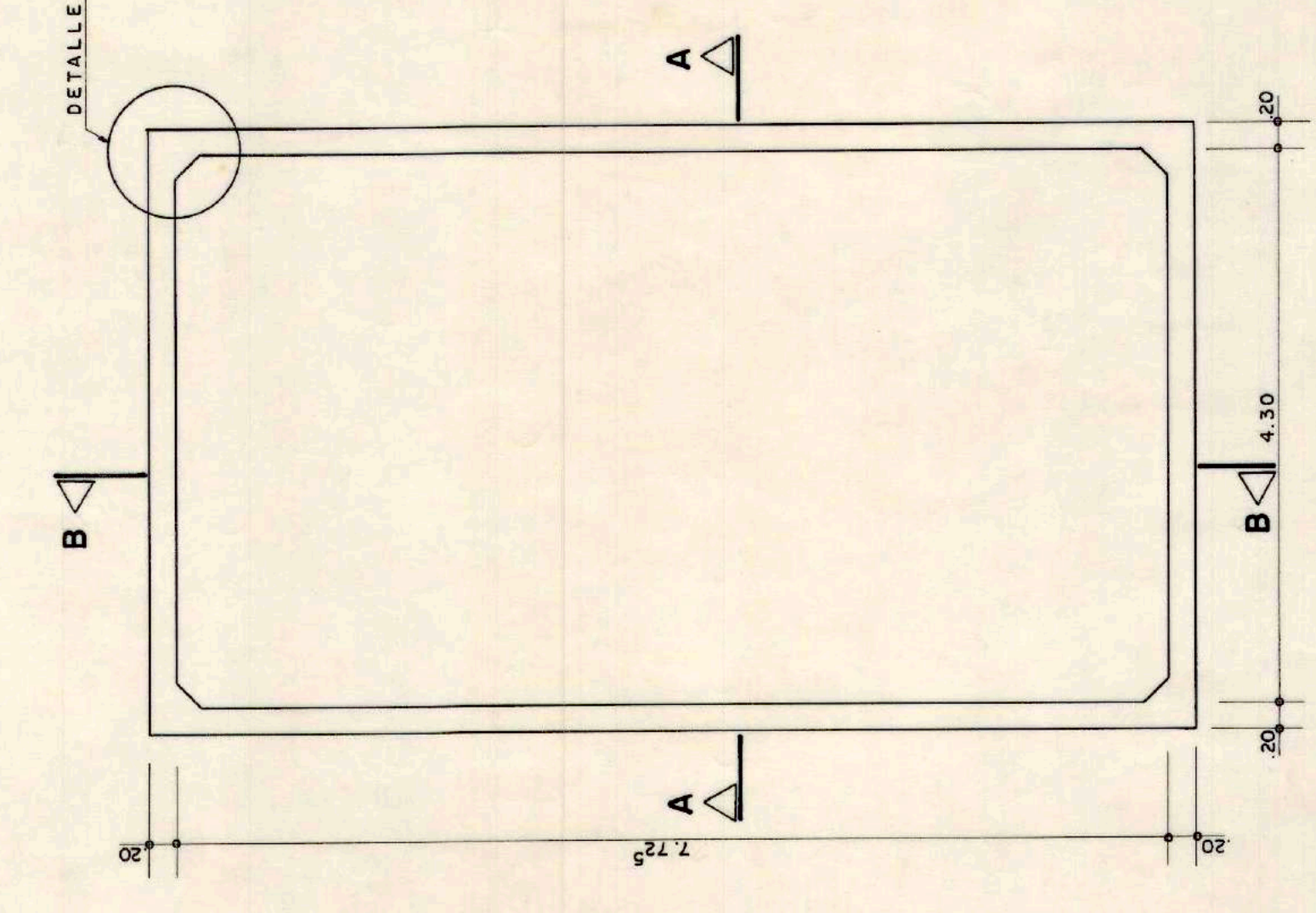

PLANTA TANQUE BAJO
esc. 1:50

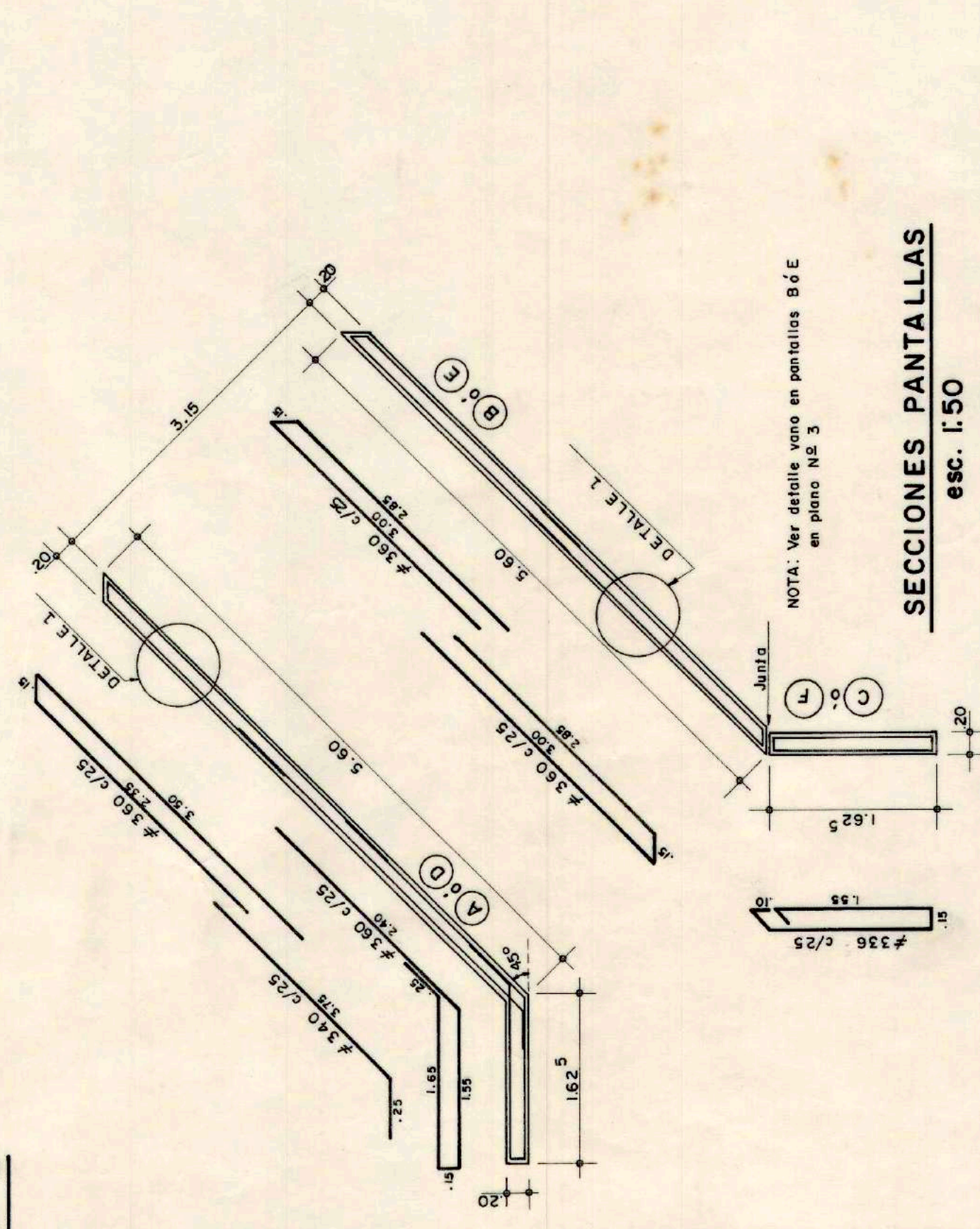

SECCIONES PANTALLAS
esc. 1:50

NIVELES Y DISTRIBUCION DE FLEJES	PANTALLAS A, B, C, D, E, F DESPIECE	INCLINACION	FLEJES # 3	FLEJES # 4
1.1	#325	14/75	#350	#350
1.2	#350	14/75	#350	#350
1.3	#350	14/75	#350	#350
1.4	#350	14/75	#350	#350
1.5	#350	14/75	#350	#350
1.6	#350	14/75	#350	#350
1.7	#350	14/75	#350	#350
1.8	#350	14/75	#350	#350
1.9	#350	14/75	#350	#350
1.10	#350	14/75	#350	#350
1.11	#350	14/75	#350	#350
1.12	#350	14/75	#350	#350
1.13	#350	14/75	#350	#350
1.14	#350	14/75	#350	#350
1.15	#350	14/75	#350	#350
1.16	#350	14/75	#350	#350
1.17	#350	14/75	#350	#350
1.18	#350	14/75	#350	#350
1.19	#350	14/75	#350	#350
1.20	#350	14/75	#350	#350

NIVELES Y DISTRIBUCION DE FLEJES	PANTALLAS D, E, F DESPIECE	INCLINACION	FLEJES # 3	FLEJES # 4
1.1	#340	14/75	#340	#340
1.2	#340	14/75	#340	#340
1.3	#340	14/75	#340	#340
1.4	#340	14/75	#340	#340
1.5	#340	14/75	#340	#340
1.6	#340	14/75	#340	#340
1.7	#340	14/75	#340	#340
1.8	#340	14/75	#340	#340
1.9	#340	14/75	#340	#340
1.10	#340	14/75	#340	#340
1.11	#340	14/75	#340	#340
1.12	#340	14/75	#340	#340
1.13	#340	14/75	#340	#340
1.14	#340	14/75	#340	#340
1.15	#340	14/75	#340	#340
1.16	#340	14/75	#340	#340
1.17	#340	14/75	#340	#340
1.18	#340	14/75	#340	#340
1.19	#340	14/75	#340	#340
1.20	#340	14/75	#340	#340

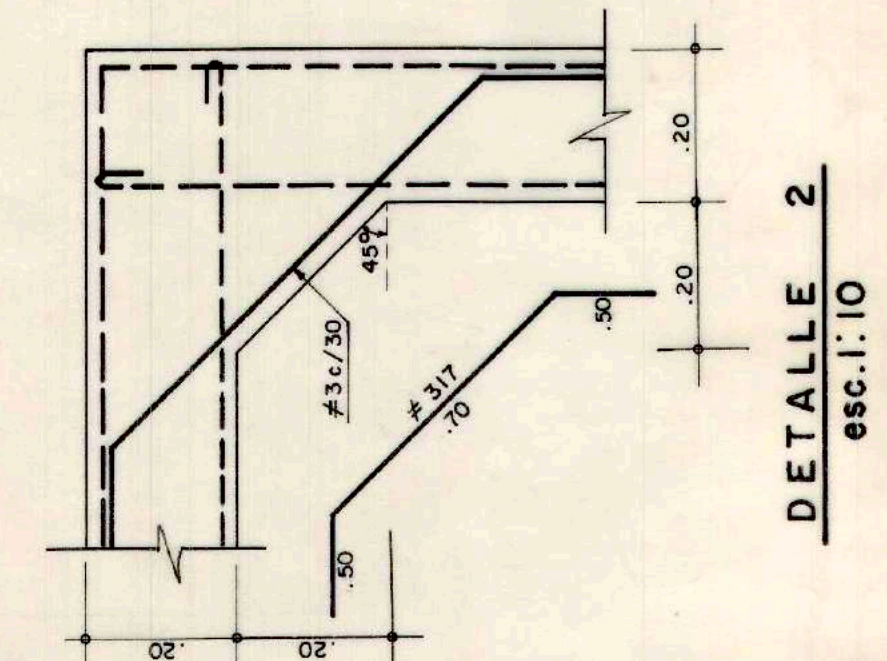

DETALLE 2
esc. 1:10

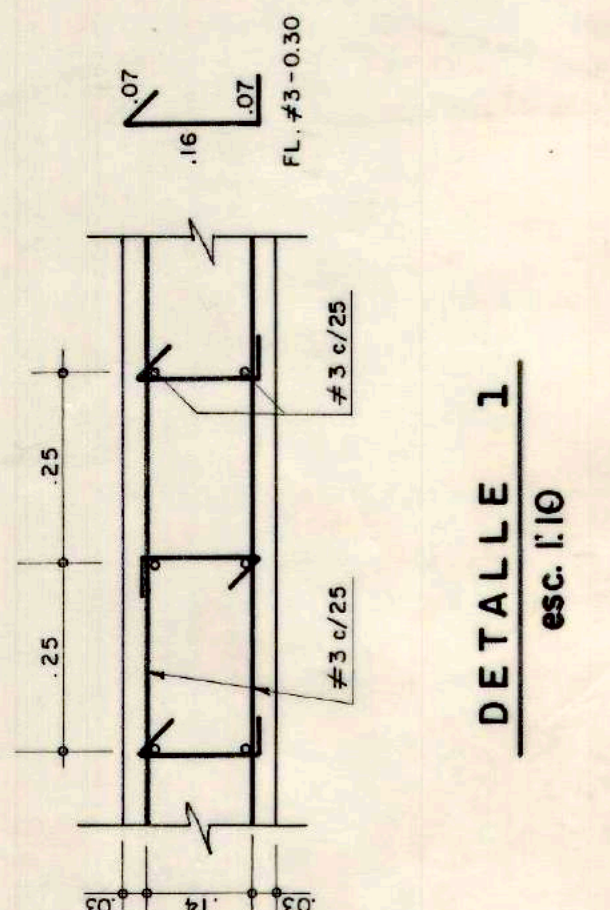

DETALLE 1
esc. 1:10

